

# ASCENSOR ELÉCTRICO - SCM - Pórtico

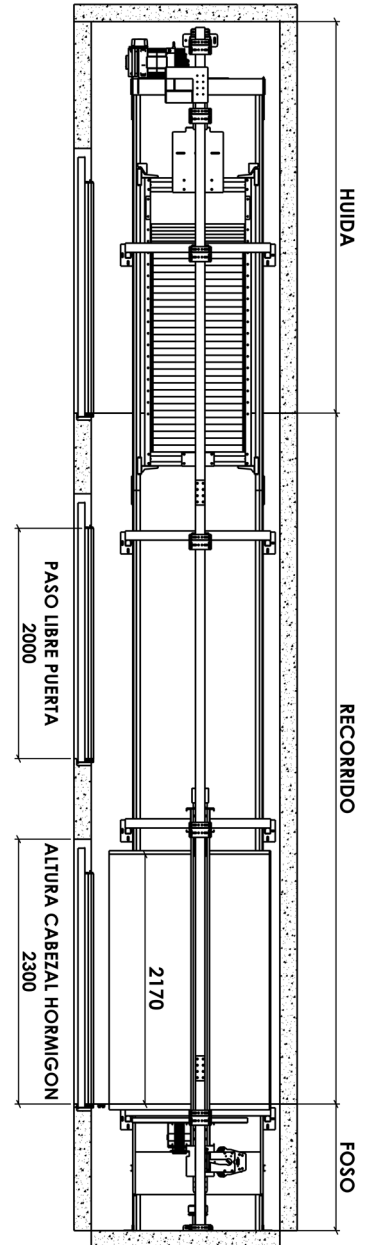

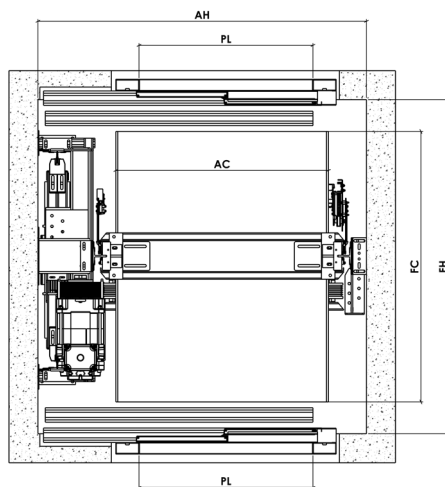
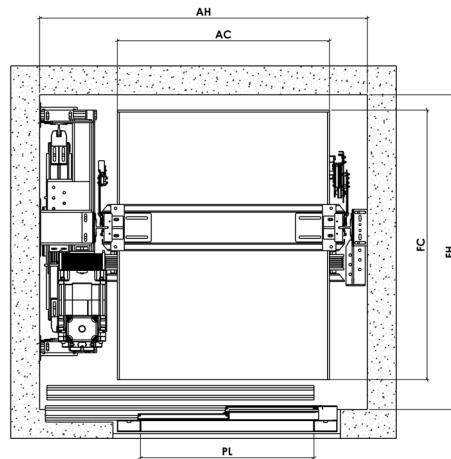
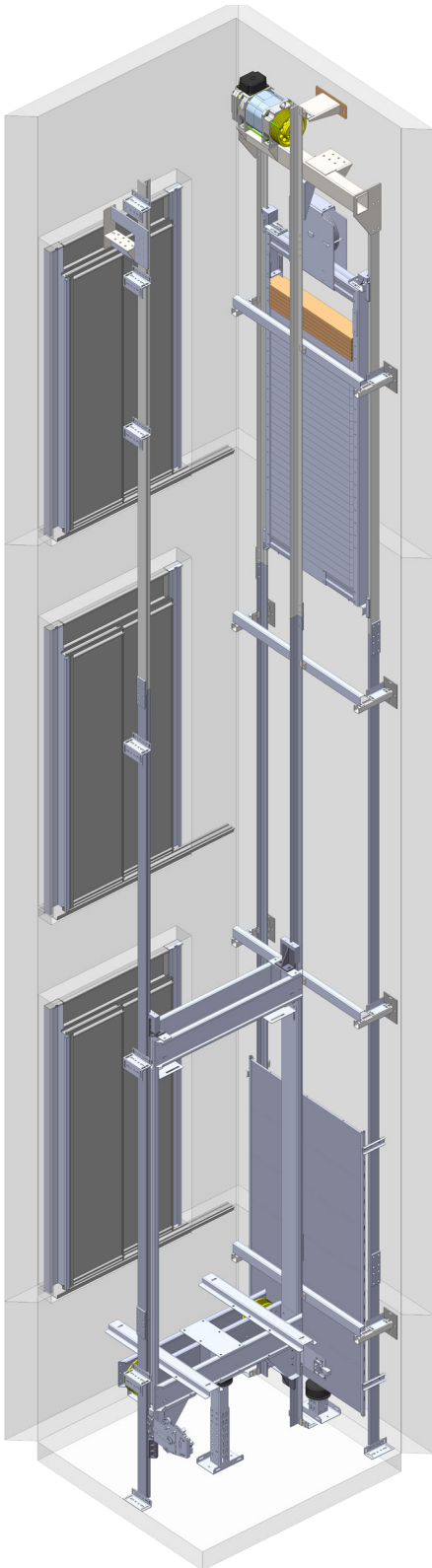

## SISTEMA PARA MEDIO-ALTO TRAFICO.

- Alta eficiencia, robustez, confort y fiabilidad.
- Máquina eléctrica de alta eficiencia energética.
- Sistema de rescate en ausencia de corriente.
- Ecodiseño, tecnología de tracción ecológica, iluminación de bajo consumo, máquina sin aceites.

# ASCENSOR ELÉCTRICO - SCM - Pórtico

CARGA (kg.)	CABINA (mm)		PUERTAS (mm)		AH (mm)	FH (mm)					
	AC	FC	PL	TIPO		1 EMBARQUE			2 EMBARQUES		
						PVS	PV	PCV	PVS	PV	PCV
320	800	1000	700	2HT	1390	1235	1300	1350	1330	1440	1540
				2HC	1540	1210	1250	1320	1280	1340	1480
375	900	1100	700	2HT	1490	1335	1400	1450	1430	1540	1640
				2HC	1540	1310	1350	1420	1380	1440	1580
375 	900	1200	800	2HT	1490	1435	1500	1550	1530	1640	1740
				2HC	1740	1410	1450	1520	1480	1540	1680
450 	1000	1250	800	2HT	1590	1485	1550	1600	1580	1690	1790
				2HC	1740	1460	1500	1570	1530	1590	1730
630 	1100	1400	900	2HT	1690	1635	1700	1750	1730	1840	1940
				2HC	1940	1610	1650	1720	1680	1740	1880
800 	1200	1500	900	2HT	1875	1735	1800	1850	1830	1940	2040
				2HC	1940	1710	1750	1820	1780	1840	1980
1000 	1300	1700	1000	2HT	2015	1935	2000	2050	2030	2140	2240
				2HC	2140	1910	1950	2020	1980	2040	2180

FOSOS Y HUIDAS						
CARGA (kg.)	ESTÁNDAR (EN81-1:2001+A3) 				REDUCIDAS (EN81.21:2009) 	
	1 m/s		1,6 m/s		1 m/s	
	FOSO	HUIDA	FOSO	HUIDA	FOSO	HUIDA
320	1100	3450	1400	3700	220	2800
375	1100	3450	1400	3700	220	2800
450	1100	3450	1400	3700	220	2800
630	1100	3450	1400	3700	220	2800
800	1150	3450	1450	3700	220	2900
1000	1150	3450	1450	3700	260	2900

MOCHETAS				
CARGA (kg.)	PUERTAS (mm)		MOCHETAS	
	PL	TIPO	M1	M2
320	700	2HT	360	90
		2HC	300	300
375	700	2HT	390	160
		2HC	300	300
375 	800	2HT	390	160
		2HC	300	300
450 	800	2HT	390	160
		2HC	350	350
630 	900	2HT	390	160
		2HC	400	400
800 	900	2HT	520	215
		2HC	400	400
1000 	1000	2HT	530	225
		2HC	450	450

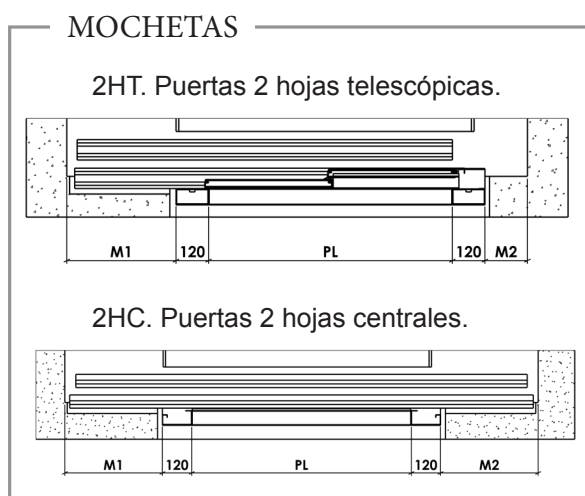

\* Dimensiones de fosos reducidos considerando suelo de goma.

\*\* Dimensiones de huidas reducidas considerando altura de cabina interior 2050mm.

\*\*\* Para compatibilización de medidas entre foso y huida reducida, y características fuera de tabla, consultar a Beltrán ascensores y montacargas, S.L.